

Drop-In Drop-in tempered glass top (4 GN container capacity) with A overshelf

ITEM # _____

MODEL # _____

NAME # _____

SIS # _____

AIA # _____

341182 (D04C4)

 Drop-in Tempered Glass Top
 (4 GN container capacity)
 with one A type overshelf
 and halogen lamp

Short Form Specification

Item No.

Designed to serve the food in plates, casseroles, pans It comes with stylish black coloured tempered heated glass with integrated etched foil elements and stainless steel framed. Special design etched foil heating elements to maximize heat transmission on the surface for having the same temperature on the whole surface. Ideal for elegant buffet to display warm food, such as pizza, bun, etc. thanks to the extended surface top. CHAR(13)CHAR(10) AISI 304 Stainless steel frame with rounded corners to facilitate cleaning operations Stylish A type overshelf designed for extra increased visibility on the surface for charming food display. Overshelf equipped with hot halogen lamps.

Main Features

- Electronic overheating protection.
- Precise temperature control and setting at 0,1°C .
- As standard the product comes with digitally controlled thermostat which is in line of HACCP norms and provides visual alarm as a warning of the increasing or decreasing temperatures.
- Designed to serve the food in plates, casseroles, pans
- It comes with stylish black coloured tempered heated glass with integrated etched foil elements and stainless steel framed.
- Special design etched foil heating elements to maximize heat transmission on the surface for having the same temperature on the whole surface.
- Ideal for elegant buffet to display warm food, such as pizza, bun, etc. thanks to the extended surface top.
- CB and CE certified by a third party notified body.
- Food introduced at the correct temperature maintains its core temperature according to Afnor Standards.
- Stylish A type overshelf designed for extra increased visibility on the surface for charming food display.
- Overshelf equipped with hot halogen lamps.
- Designed to be positioned in flush installation providing improved cleanability and suitable for modern design installations.

Construction

- Electronic control with temperature display.
- AISI 304 Stainless steel frame with rounded corners to facilitate cleaning operations
- IPx4 water protection.
- Heating elements connected to the bottom include safety thermostat.
- Overshelf in complete AISI 304.

APPROVAL: _____

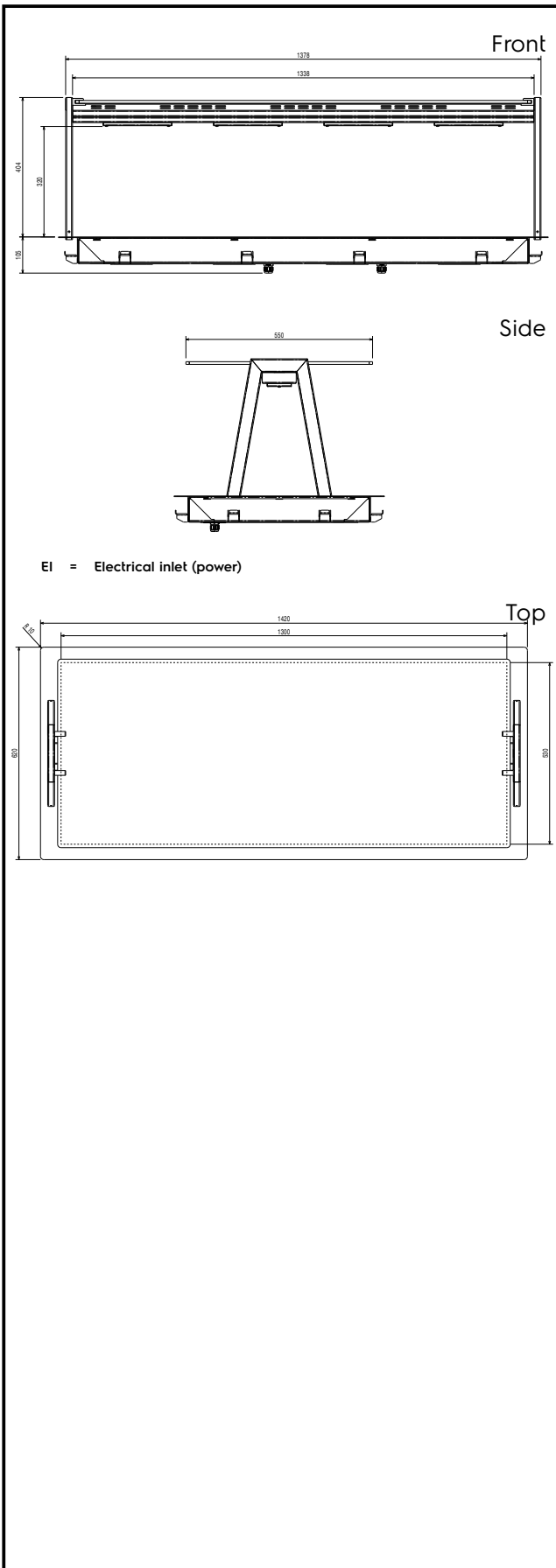

Electric

Supply voltage:

341182 (D04C4)

220-240 V/1N ph/50/60 Hz

Electrical power max.:

1.18 kW

Key Information:

External dimensions, Width: 1420 mm

External dimensions, Depth: 620 mm

External dimensions, Height: 484 mm

Net weight: 45.35 kg

Shipping weight: 73 kg

Shipping height: 910 mm

Shipping width: 670 mm

Shipping depth: 1480 mm

Shipping volume: 0.9 m³

Set temperature: +105 / +115 °C

Sustainability

Noise level:

Drop-In
 Drop-in tempered glass top (4 GN container capacity) with A overshelf

The company reserves the right to make modifications to the products without prior notice. All information correct at time of printing.

2024.04.11

